

Eva Kormaníková<sup>1</sup>

## NUMERICAL MODELING OF COMPOSITE LAMINATE PLATE

### Introduction

Fast development of composites has provided the incentive for dealing with one of the most severe defects in such structures - delamination. Delamination originates from manufacturing imperfections, cracks produced by fatigue or low velocity impact, stress concentration near joints and free edges, or due to high interlaminar stresses.

Many recent papers devoted to delamination are focused on the problem of proper modeling of delamination initiation and growth. Iannucci [1] proposes an interface modeling technique for explicit FE codes. In the technique, based on fracture mechanics, not only a stress threshold for damage commencement, but also critical energy release rate for particular delamination mode is used. The interface modeling technique was applied to a series of common delamination tests, including an experimentally validated impact test, to show the superiority of the approach over standard stress-based failure criterion. Conventional interface modeling methods suffer from several shortcomings i.e. interface elements have to be introduced a priori, spurious deformation occurs at onset of delamination, traction oscillations accompany the process of delamination growth, finite elements have to be aligned with potential delamination surface. These unwanted features can be avoided by modeling delamination at a mesoscopic level.

### 1. Effective material moduli for composites

Composite materials have at least two different material components which are bonded. The material response of a composite is determined by the material moduli of all constituents, the volume or mass fractions of the single constituents in the composite material, by the quality of their bonding, i.e. of the behaviour of the interfaces, and by the arrangement and distribution of the fibre reinforcement,

---

<sup>1</sup> Technical University of Košice, Faculty of Civil Engineering, Slovak Republic, e-mail: eva.kormanikova@tuke.sk

i.e. the fibre architecture. The basic assumptions made in material science approach models of fibre reinforced composites are [2]:

- The bond between fibres and matrix is perfect.
- The fibres are continuous and parallel aligned in each ply, they are packed regularly, i.e. the space between fibres is uniform.
- Fibre and matrix materials are linear elastic, they follow approximately Hooke's law and each elastic modulus is constant.
- The composite is free of voids.

Composite materials are heterogeneous, but in simplifying the analysis of composite structural elements in engineering applications, the heterogeneity of the material is neglected and approximately overlaid to a homogeneous material. Each single layer of laminates or sandwich faces is in general a fibre reinforced lamina.

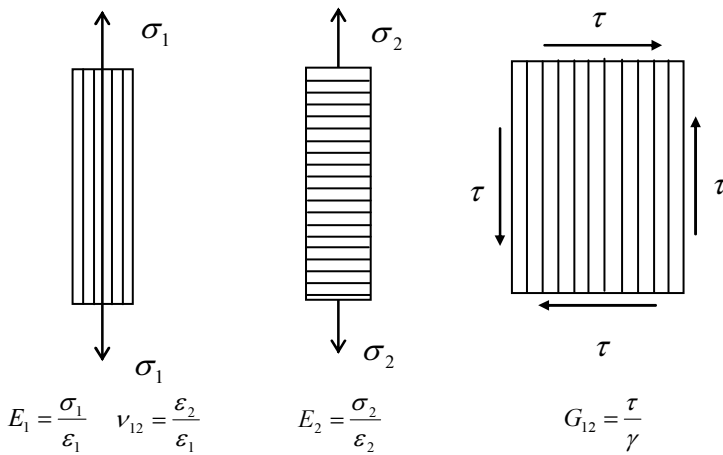

Fig. 1. Experimental testing of the mechanical properties of an UD-layer

Fibre reinforced material is in practice neither monolithic nor homogeneous, but it is impossible to incorporate the real material structure into design and analysis of composite or any other structural component. Therefore the concept of replacing the heterogeneous material behaviour with an effective material which is both homogeneous and monolithic, thus characterized by the generalized Hooke's law, will be used in engineering applications. There are assumed that the local variations in stress and strain state are very small in comparison to macroscopically measurements of material behaviour (Fig. 1).

## 2. Delamination modeling

Perfect adhesion is assumed in the undelaminated region, whereas sublaminates are free to deflect along the delaminated region but not to penetrate each other. To enforce adhesion, a linear interface model is introduced. The constitutive equation

of the interface involves two stiffness parameters,  $k_z$ ,  $k_{xy}$ , imposing displacement continuity in the thickness and in-plane direction, respectively, by treating them as penalty parameters. The relationship between the components of the traction vector  $\sigma$  acting at the lower surface of the upper sublaminar,  $\tau_{zx}$ ,  $\tau_{zy}$  and  $\sigma_z$ , in the out-of-plane and in the in-plane direction, respectively, and the corresponding components of relative interface displacement vector are expressed as

$$\sigma = \mathbf{K}\Delta \quad (1)$$

or in matrix form as

$$\begin{pmatrix} \tau_{zx} \\ \tau_{zy} \\ \sigma_z \end{pmatrix} = \begin{pmatrix} k_{xy} & 0 & 0 \\ 0 & k_{xy} & 0 \\ 0 & 0 & k_z \end{pmatrix} \begin{pmatrix} \Delta u \\ \Delta v \\ \Delta w \end{pmatrix} \quad (2)$$

Relative opening and sliding displacements are evaluated as the difference between displacements at the interface between the lower and upper sublaminar.

### 2.1. Energy Release Rate (ERR) - interface modeling

The problem of ERR computation can be solved locally by using interface variables it means interlaminar stresses and relative variables [3]. The connection between the interface approach and fracture mechanics approach will be established, that interface approach corresponds to the limit physical situation when the thickness of a thin adhesive layer tends to zero. Using the interface constitutive equation (2) to compute interlaminar stresses leads to the following total ERR expression

$$G = \frac{1}{2} \lim_{k_z, k_{xy} \rightarrow \infty} [k_z \Delta w^2 + k_{xy} \Delta u^2 + k_{xy} \Delta v^2] \quad \Delta w \geq 0 \quad (3)$$

where  $G$  is the local ERR function along the delamination front. The point-wise  $G$  and its mode I, II, III take the following form

$$G = G_I + G_{II} + G_{III} \quad (4)$$

$$G_I = \begin{cases} \lim_{k_z, k_{xy} \rightarrow \infty} \frac{1}{2} k_z \Delta w^2, & \text{if } \Delta w \geq 0 \\ 0 & \text{if } \Delta w \leq 0 \end{cases} \quad \text{- unilateral contact conditions}$$

$$G_{II} = \lim_{k_z, k_{xy} \rightarrow \infty} \frac{1}{2} k_{xy} \Delta u^2$$

$$G_{III} = \lim_{k_z, k_{xy} \rightarrow \infty} \frac{1}{2} k_{xy} \Delta v^2 \quad (5)$$

## 2.2. Mixed-mode analysis

Fracture mechanics assumes that delamination propagation is controlled by the critical ERR [4]. Delamination grows on the region of the delamination front where the following condition is satisfied

$$\left(\frac{G_I}{G_I^C}\right)^\alpha + \left(\frac{G_{II}}{G_{II}^C}\right)^\beta + \left(\frac{G_{III}}{G_{III}^C}\right)^\gamma \geq 1 \quad (6)$$

where  $\alpha, \beta, \gamma$  are mixed mode fracture parameters determined by fitting to experimental test results,  $G_I^C, G_{II}^C, G_{III}^C$  are assume to be material properties, independent of their location along the delamination front, and evaluated from experimental procedures.

The expression (3) and (5), obtained from interface model, can be used in conjunction with a finite element method to check whether propagation occurs. The extent of the propagation of the delamination area can be established by releasing in which the relation (6) is first satisfied, leading to modification of the delamination front. Therefore the delamination growth analysis must be accomplished iteratively [5].

ERR are computed by using [6]:

$$G_I(A) = \frac{1}{2} \frac{R_A^z \Delta w_{B-B'}}{\Delta_n \Delta_t} \quad G_{II}(A) = \frac{1}{2} \frac{R_A^n \Delta u_{nB-B'}}{\Delta_n \Delta_t} \quad G_{III}(A) = \frac{1}{2} \frac{R_A^t \Delta u_{tB-B'}}{\Delta_n \Delta_t} \quad (7)$$

where  $R_A^z, R_A^n, R_A^t$  are the reactions in the spring element connecting node A in the  $z$ , normal and tangential direction to the delamination front  $s$ ,  $\Delta w_{B-B'}, \Delta u_{nB-B'}, \Delta u_{tB-B'}$  are the relative  $z, n, t$  displacements between the nodes B and B' located immediately ahead of the delamination front along its normal directions passing through A,  $\Delta_t$  and  $\Delta_n$  are the characteristic mesh sizes in the normal and tangential directions (Fig. 2).

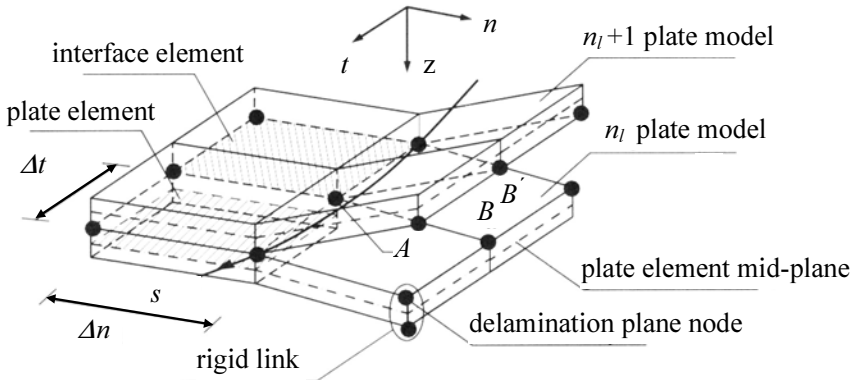

Fig. 2. Plate assembly in the neighborhood of the delamination front

### 2.3. Example of delamination modeling

The effectiveness of the proposed model is now verified for the laminate plate consists of two sublaminates (1-1 model). The sublaminates consist of carbon epoxy UD composite. Material characteristics of the carbon fibres are  $E_f = 230$  GPa,  $\nu_f = 0.2$ , for the epoxy matrix are  $E_m = 3.45$  GPa,  $\nu_m = 0.38$ . Fibre volume fraction is  $\xi = 0.6$ . The fibre diameter is  $d_f = 7$   $\mu\text{m}$ , placed in an hexagonal array. The sublaminates are loaded by opening load  $F = 1$  N/mm and diameters of the laminate plate are shown in Figure 3. The example is solved with the help of Finite Element Method [6] of FEM program ANSYS.

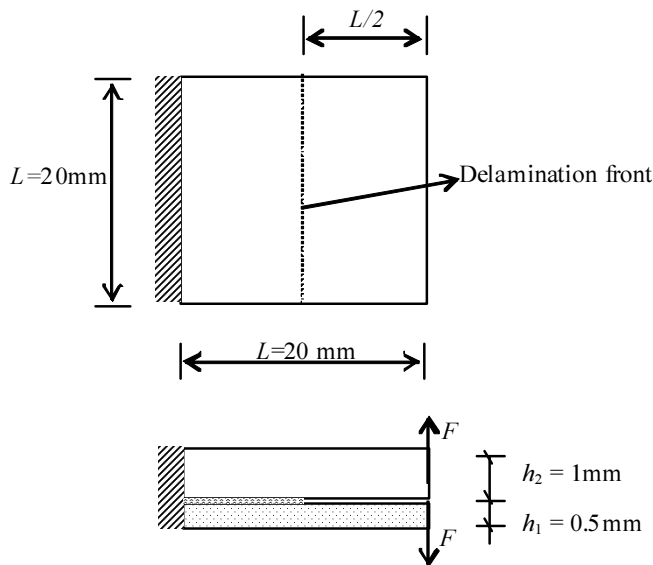

Fig. 3. Laminates geometry

TABLE 1

#### Summary of results

|                | Voigt-Reuss model | Halpin and Tsai model [1]<br>$\zeta_E = 1.5$ | Periodic microstructure model | Numerical model |
|----------------|-------------------|--|-------------------------------|-----------------|
| $E_1$ [GPa]    | 139.38            | 139.38                                       | 139.4162                      | 139.409         |
| $E_2$ [GPa]    | 8.4352            | 15.2348                                      | 14.5859                       | 14.363          |
| $\nu_{12}$     | 0.272             | 0.272  | 0.2627                        | 0.263           |
| $G_{12}$ [GPa] | 3.065             | 5.5798                                       | 4.8185                        | 4.875           |

The numerical model is suitable for analytical approach of modelling of unidirectional lamina. The results from this model are very similar to the results obtained from the periodic microstructure model.

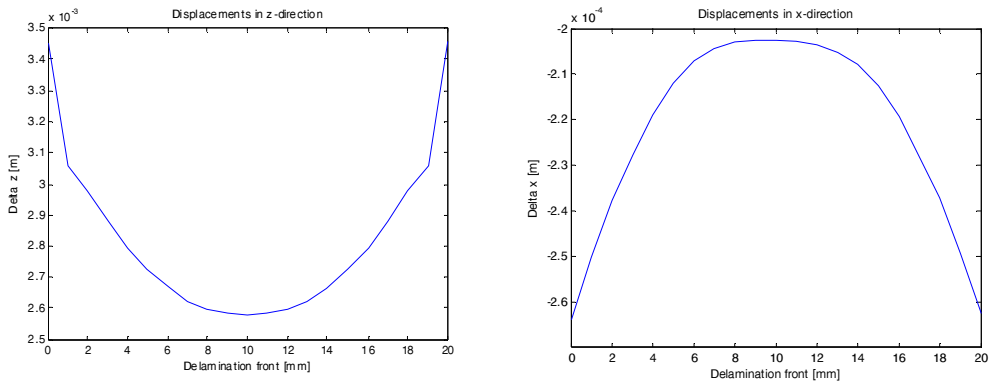

Fig. 4. Relative displacements in z and x-directions, respectively along the delamination front

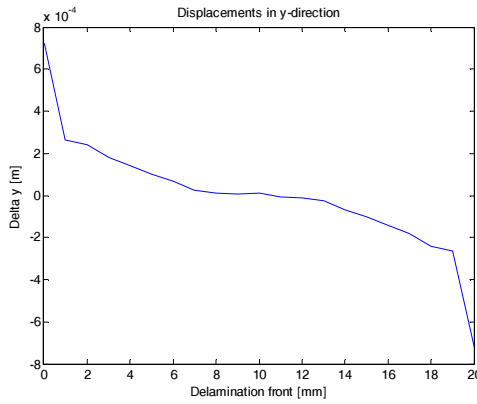

Fig. 5. Relative displacement in y-directions along the delamination front

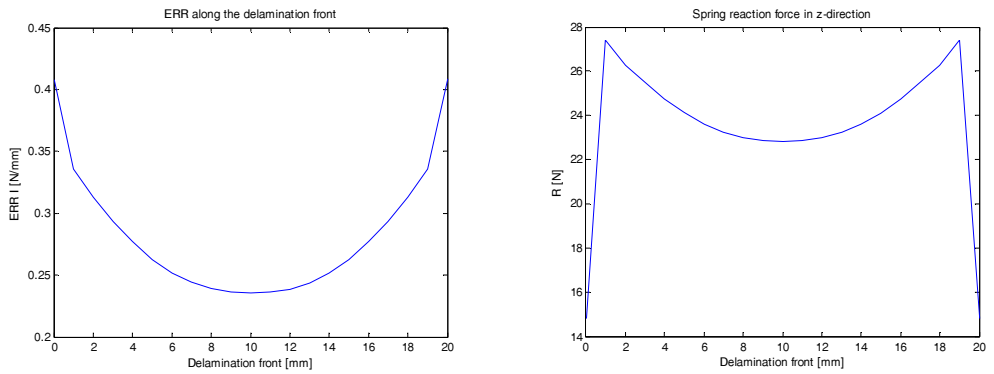

Fig. 6. ERR I and spring reaction force in z-direction along the delamination front

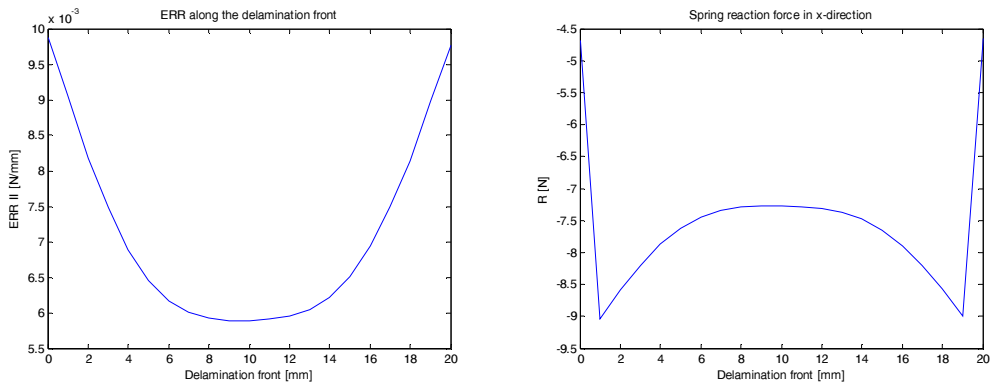

Fig. 7. ERR II and spring reaction force in  $x$ -direction along the delamination front

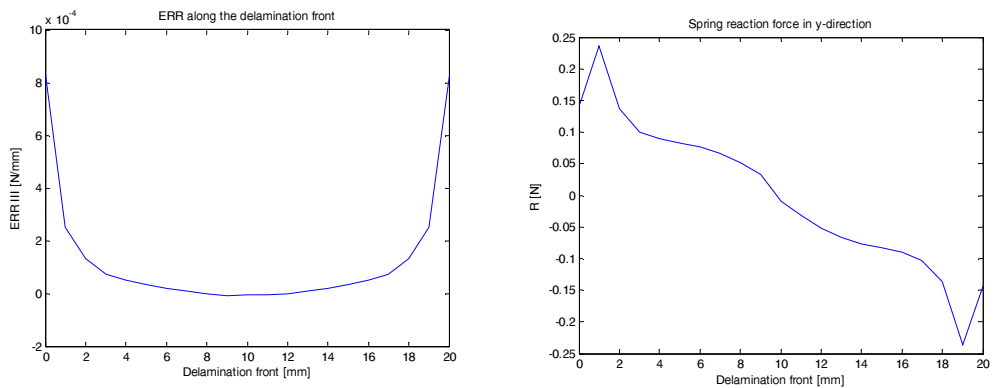

Fig. 8. ERR III and spring reaction force in  $y$ -direction along the delamination front

## Conclusions

The effectiveness of the numerical model was verified for the laminate plate consists of two sublaminates (1-1 model).

In the frame of homogenization very closed results were obtained from the numerical model and periodic microstructure model (Table 1). The numerical model was used for analytical approach of modelling of unidirectional lamina in the example (Fig. 3).

The delamination of laminate plate was represented by using two sublaminates, one for the portion above the delamination plane and the other one for the part below. Sublaminates were modeled by using shear deformation theory.

Figures 4 and 5 show contour plot of displacements in  $z$ ,  $x$  and  $y$ -directions, respectively along the delamination front. ERR and spring reaction forces along the delamination front were calculated (Figs. 6-8). The interface elements with coupling constrain equations were used for interface model with calculated the reaction forces in the springs. Coupling effect occurs in the unsymmetrical laminate

plate to the mid-plane (ERR I, II, III). Mode I is predominant, modes II and III are negligible.

Unlike cracks in homogeneous media, which follow a path maintaining a pure mode I at their tip, delamination at the interface of the composite laminate plates involves coupled fracture modes. Determination of the individual components of ERR is a complex and indispensable task due to the mixed-mode dependence of the delamination criterion.

### Acknowledgement

*This paper has been supported by the project VEGA 1/0477/15 Progressive methods for the solution of structural elements made of composite and other new-age materials.*

### References

- [1] Iannucci L., Dynamic delamination modelling using interface elements, *Comput. Structure* 2006, 84, 1029-48.
- [2] Altenbach H., Altenbach J., Kissing W., *Structural Analysis of Laminate and Sandwich Beams and Plates*, Lublin 2001.
- [3] Gürdal Z., Haftka R.T., Hajela P., *Design and Optimization of Laminated Composite Materials*, J. Wiley & Sons, 1999.
- [4] Bareš R.A., *Composite materials*, SNTL, Praha 1988.
- [5] Agarwal B.D., Broutman L.J., *Fiber Reinforced Composites*, Praha 1987.
- [6] Barbero E.J., *Finite Element Analysis of Composite Materials*, CRC Press, USA, 2007.

### Abstract

The paper deals with numerical modeling of delamination of laminate plate consists of unidirectional fiber reinforced layers. The methodology adopts the first-order shear laminate plate theory and fracture and contact mechanics. There are described sublaminar modeling and delamination modeling by the help of finite element analysis. With the interface modeling there is calculated the energy release rate along the lamination front. Analytical expressions for total energy release rate and its mode components are given in terms of interface variables and plate stress resultant discontinuities. Numerical results are given for mixed mode delamination problems by implementing the method in a 2D finite analysis, which utilizes shear deformable plate elements and interface elements. Numerical example is done by the commercial ANSYS code.

**Keywords:** delamination, fiber reinforced layers, laminate structure, plate elements, contact elements, numerical modeling

## Modelowanie numeryczne kompozytowej płyty laminowanej

### Streszczenie

Artykuł dotyczy numerycznego modelowania rozwarstwienia płyty laminowanej składającej się z warstw zbrojonych jednokierunkowo włóknami. W metodologii przyjęto teorię płyty laminowanej



na ścinanie pierwszego rzędu oraz mechanikę pęknięcia i kontaktu. Opisano modelowanie sublaminate i modelowanie delaminacji za pomocą analizy elementów skończonych. Przy modelowaniu interfejsu obliczono szybkość uwalniania energii wzdłuż czoła laminatu. Wyrażenia analityczne dla całkowitej szybkości uwalniania energii i jej składników modalnych podano w odniesieniu do zmiennych interfejsowych i wynikających z nich nieciągłości naprężeń płyt. Wyniki liczbowe podano dla problemów delaminacji w trybie mieszanym poprzez zastosowanie metody w dwuwymiarowej skończonej analizie, która wykorzystuje odkształcalne na ścinanie elementy płytowe i elementy interfejsu. Przykład numeryczny obliczono z wykorzystaniem programu ANSYS.

**Słowa kluczowe:** rozwarstwienie, warstwy wzmocnione włóknami, struktura laminatu, elementy płytkowe, elementy stykowe, modelowanie numeryczne